



T|eddy

Sonden und Sondensysteme





Handsonde stiftförmig (Typ: HS1)

Element	Spulenprinzip	Prüffrequenz f_{min} f_{max}	Keramikform	Art.-nr.
■ AS7	Differenz	25 kHz – 1,0 MHz	flach	AS7-HS1-6C30
■ DDS33	Differenz	10 kHz – 2,0 MHz	flach	DDS33-HS1-6C25
■ PD23	Differenz	75 kHz – 5,0 MHz	flach	PD23-HS1-6C25
■ PDS23	Differenz	75 kHz – 5,0 MHz	spitz	PDS23-HS1-6SF2
■ SA60	Absolut	25 kHz – 1,0 MHz	kegelig	SA60-HS1-PC68
■ SD60	Differenz	25 kHz – 4,0 MHz	spitz	SD60-HS1-6SF2
■ SD60	Differenz	25 kHz – 4,0 MHz	flach	SD60-HS1-6C17

Standardkontaktierung: Fischer D102 A (4-polig)

SONDERAUSFÜHRUNGEN AUF ANFRAGE

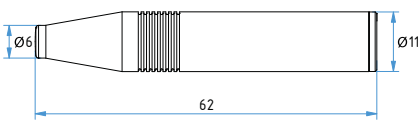

flach

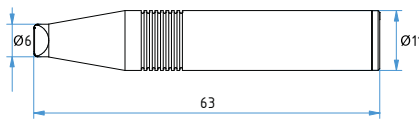
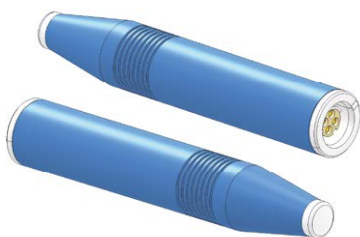

spitz

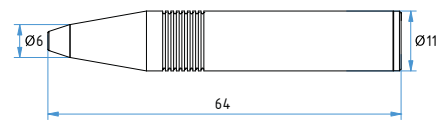

kegelig



Handsonde hakenförmig (Typ: HS2)

Element	Spulenprinzip	Prüffrequenz f_{\min} f_{\max}	Keramikform	Art.-nr.
■ AS7	Differenz	25 kHz – 1,0 MHz	flach	AS7-HS2-KF07
■ DDS33	Differenz	10 kHz – 2,0 MHz	flach	DDS33-HS2-KF07
■ PD23	Differenz	75 kHz – 5,0 MHz	flach	PD23-HS2-KF07
■ PDS23	Differenz	75 kHz – 5,0 MHz	spitz	PDS23-HS2-6SF2
■ SA60	Absolut	25 kHz – 1,0 MHz	spitz	SA60-HS2-PC78
■ SD60	Differenz	25 kHz – 4,0 MHz	flach	SD60-HS2-KF07

Standardkontaktierung: Fischer D102 A (4-polig)

SONDERAUSFÜHRUNGEN AUF ANFRAGE

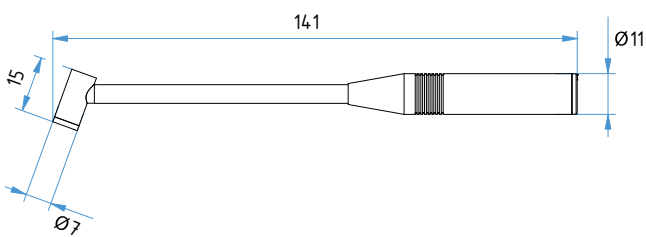

flach

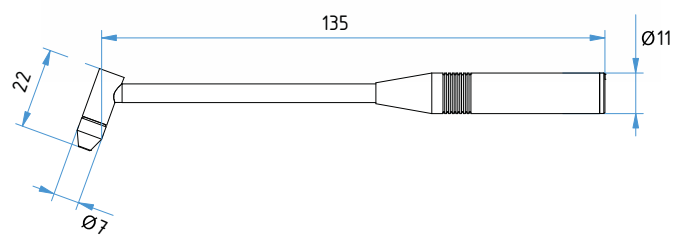

spitz



Halbtransmissionssonden

Typ	Spulenprinzip	Topfkern-Ø	Prüffrequenz		Winkel	Art.-nr.
			f_{min}	f_{max}		
■ MT-DK011	halbtransmission	Ø 11,0 mm	100 Hz – 2,0 kHz		130°	MT-DK011-130
■ MT-DK011	halbtransmission	Ø 11,0 mm	100 Hz – 2,0 kHz		180°	MT-DK011-180
■ MT-DK014	halbtransmission	Ø 14,0 mm	100 Hz – 2,0 kHz		130°	MT-DK014-130
■ MT-DK014	halbtransmission	Ø 14,0 mm	100 Hz – 2,0 kHz		180°	MT-DK014-180
■ MT-DK018	halbtransmission	Ø 18,0 mm	100 Hz – 2,0 kHz		130°	MT-DK018-130
■ MT-DK018	halbtransmission	Ø 18,0 mm	100 Hz – 2,0 kHz		180°	MT-DK018-180

Standardkontaktierung:

Winkel 130°: Kabel mit Fischer S102 A (4-polig), Kabellänge variabel

Winkel 180°: Fischer D104 Z (8-polig)

SONDERAUSFÜHRUNGEN AUF ANFRAGE +



Fischer D104 Z

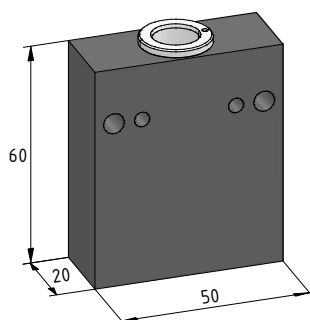

Kabel mit Fischer S102 A

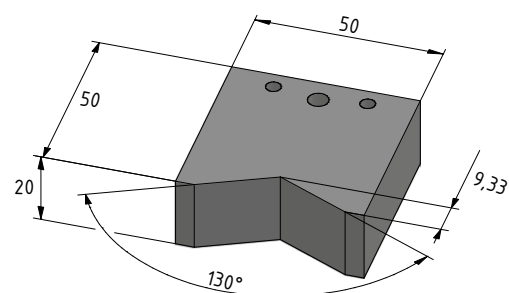

Spulen für die Gefügeprüfung

Typ	Außenabmessung	Prüffrequenz		Prüf-Ø in mm	Breite der Wickelkammer in mm
		f_{\min}	f_{\max}		
■ MTA	50 x 50 x 25 mm	100 Hz – 2,0 kHz		5, 10, 15, 20, 25	2, 5, 10, 15
■ MTB	100 x 100 x 25 mm	100 Hz – 2,0 kHz		10, 15, 20, 15, 20, 25, 30, 35, 40, 45, 50	2, 5, 10, 15
■ MTC	150 x 150 x 90 mm	100 Hz – 2,0 kHz		10, 20, 30, 40, 50, 60, 70, 80, 90, 100	10, 15, 20, 25, 30, 35, 40, 45, 50, 55, 60, 65, 70, 75, 80*
■ MTD	100 x 100 x 40 mm	100 Hz – 2,0 kHz		10, 15, 20, 15, 20, 25, 30, 35, 40, 45, 50	5, 10, 15, 20, 25, 30

* Nur für Prüfdurchmesser 40 mm

Beispiel Artikelnummer: MTA-D010-020

↑ ↑ ↙
 Typ Prüf-Ø Breite der Wickelkammer

Standardkontaktierung:

MTA: Kabel mit Fischer S102 A (4-polig), Kabellänge variabel

MTB, MTC, MTD: Fischer D104 Z (8-polig)

SONDERAUSFÜHRUNGEN AUF ANFRAGE +



MTA

MTB

MTC

MTD

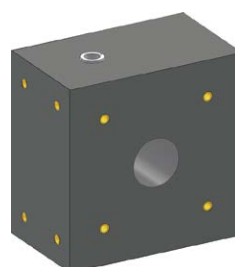
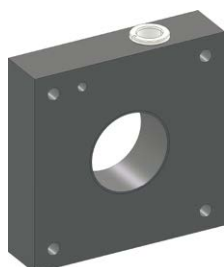
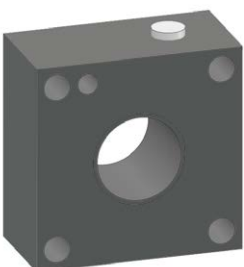

T.*eddy* – weltweit im Einsatz, hocheffizient und zuverlässig.





T.eddy pro-Serie – die innovative Prüfgerätefamilie.

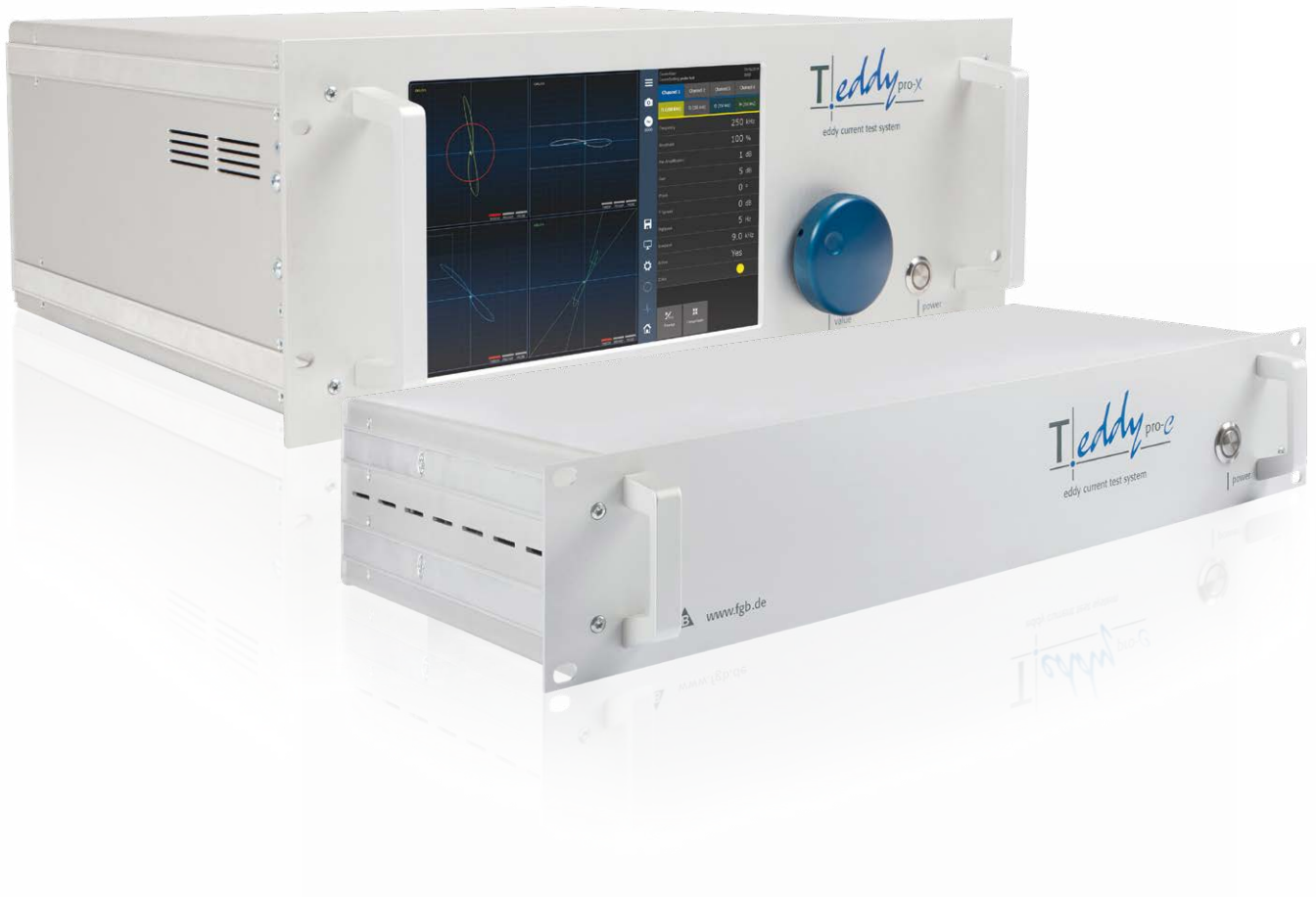



Individuelle Lösungen aus einer Hand

Seit mehr als 20 Jahren ist FGB Lieferant von leistungsstarken und komplexen Wirbelstromprüfanlagen für Kunden aus den verschiedensten Industriezweigen. Dabei liefert das Unternehmen individuell zugeschnittene Lösungen, von denen Kunden weltweit profitieren. Einzigartig ist, dass der Gesamtprozess von der Konstruktion über die Fertigung, Montage und Softwareentwicklung im eigenen Haus stattfindet.



FGB: Fertigungsgerätebau Adolf Steinbach GmbH & Co. KG

Strahlunger Straße 18 | 97616 Salz | Germany

Telefon: +49 (0) 9771 688 77-500

Telefax: +49 (0) 9771 688 77-502

www.fgb.de

E-Mail: t.eddy@fgb.de